

gantries

PBS Series
Power Block Slide



NUMATICS

Table of Contents



PBS Series Power Block Slides.....	3-6
Features and Benefits.....	3
How To Order.....	4
Technical Specifications.....	4
Dimensions.....	5
Switch Information.....	6



PBS-Series Power Block Slides

Designed for applications where space is at a minimum.

The PBS-Series has an internally built-in air cylinder in the carriage assembly, reducing overall length. The carriage assembly is supported by four recirculating linear ball bearings and two hardened guide shafts.

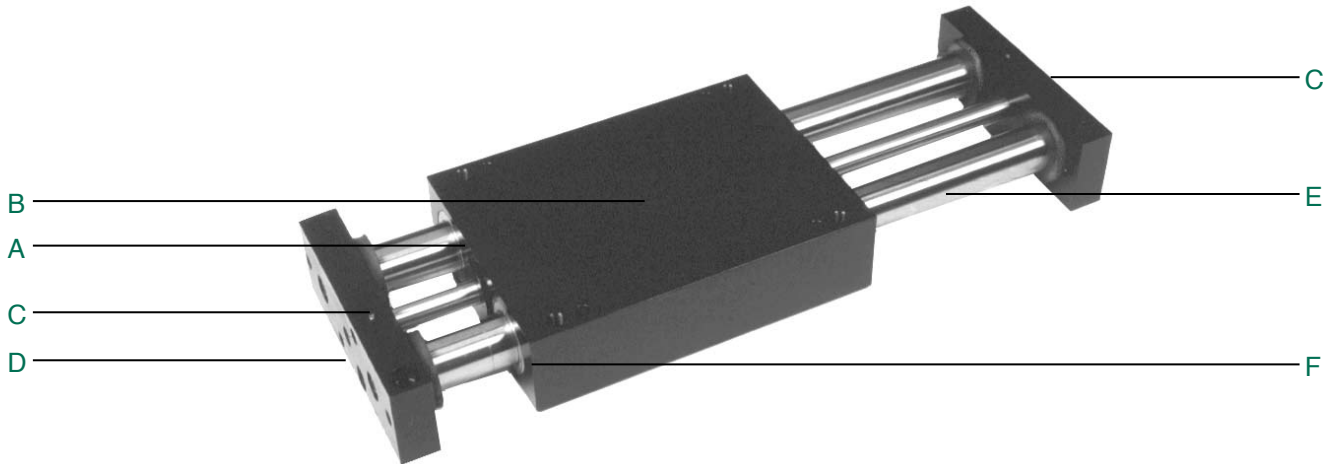

A. Carriage:

Four recirculating linear ball bearings. Easy access mounting and dowel location holes.

B. Air Cylinder:

Internally housed in carriage. Low friction U-cup lip seals for long service life.

C. Tool Bars:

Standard dowel locating holes and accurately milled locating slots. Machined to accept industry standard shock absorbers, and position proximity switch sensors.

D. Stroke Adjusting Screw:

Easy access stroke adjusting screws for exact carriage stroke. Adjustable in both directions. Maximum Stroke 6±

E. Guide Shafts:

Hardened Steel to RC 60-65

F. Bearings: (Two Choices)

Four linear ball bearings...greatest load capacity, factory lubricated, built-in wipers, self-aligning.

Four Frelon® Compounded Teflon®...self-lubricating, self-aligning, long service life, ideal for cleanroom.



PBS Series Power Block Slides

NUMATICS®

How to Order

PBS 075 03 LB 1 4 C 4

Bore Sizes

075 = 3/4 Inch
100 = 1 Inch
125 = 1-1/4 Inches

Standard Stroke

01 = 1"
02 = 2"
03 = 3"
04 = 4"
05 = 5"
06 = 6"

NOTE: Max. stroke

PBS075-4.0

PBS100-5.0

PBS125-6.0

Bearing Option

LB = Linear Ball
TB = Teflon®

Seal Option

1 = Buna-N Seals
2 = Viton Seals

Shock Absorbers

1 = Extend
2 = Retract
3 = Extend and Retract
4 = No Shocks

Sensing Position

A = Single Position Extend
B = Single Position Retract
C = Two Position Sensing
D = No Sensing

Sensing Type

Standard Cord Set

4 = Prox Switch - PNP (sourcing)

5 = Prox Switch - NPN (sinking)

6 = No Sensing

Quick Disconnect Cord Set

W = Prox Switch - PNP (sourcing) Straight

V = Prox Switch - NPN (sinking) Straight

U = Prox Switch - PNP (sourcing) 90 Deg.

T = Prox Switch - NPN (sinking) 90 Deg.

Prox switches are 8 mm diameter.

When ordering additional switches:

SWITCH DESCRIPTION	STANDARD PART NO.	QUICK DISCONNECT PART NO.
Prox Switch-PNP (Sourcing)	PX08PS	PX08PQ
Prox Switch-NPN (Sinking)	PX08NS	PX08NQ
Quick Disconnect Cable	-	PXCST
90° 5 meter cable	-	PXC90

Technical Specifications

	PBS075	PBS100	PBS125
Max. Air Pressure	120 psi	120 psi	120 psi
Thrust force @ 100 psi	31 lbs	62 lbs	100 lbs
Maximum Stroke	4.00	5.00	6.00
Cylinder Bore Dia.	0.75	1.00	1.25
F1 Load	90 lbs	275 lbs	520 lbs
F2 Load	90 lbs	275 lbs	520 lbs
Deflection @ max Load & Stk	0.003	0.003	0.003
M2 Moment	120 in.-lbs.	275 in.-lbs.	450 in.-lbs.
M3 Moment	200 in.-lbs.	750 in.-lbs.	1590 in.-lbs.
M4 Moment	200 in.-lbs.	750 in.-lbs.	1590 in.-lbs.

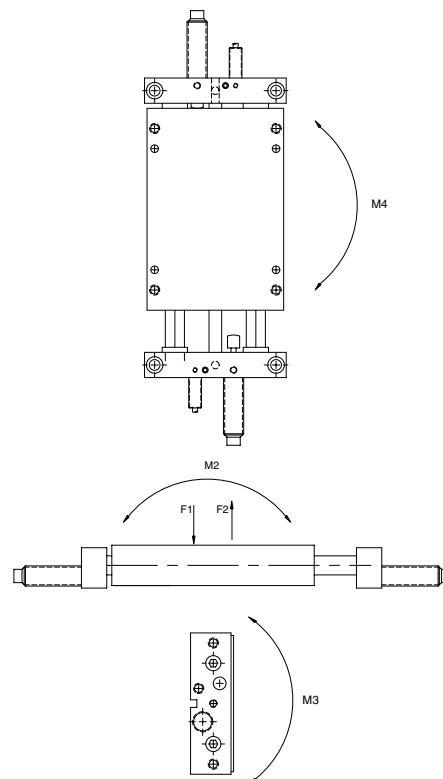



PBS-Series Power Block Slide Dimensions

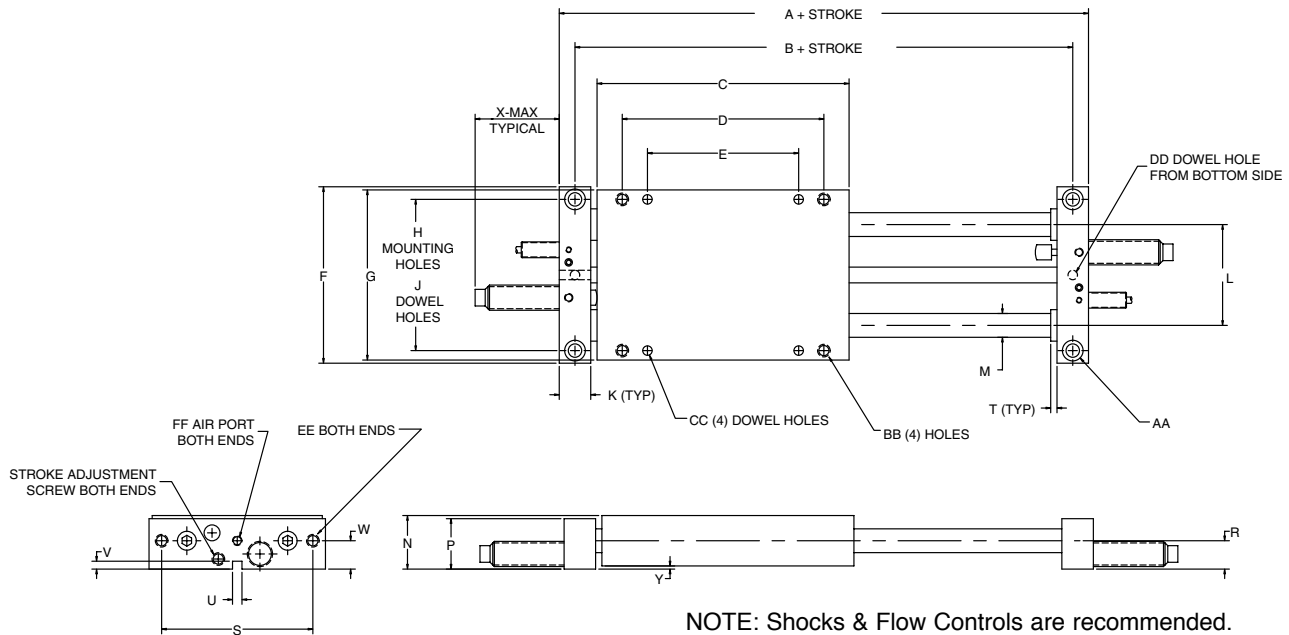

Dimensions

	PBS075	PBS100	PBS125
A	6.500	8.000	9.000
B	5.875	7.250	8.250
C	5.000	6.000	7.000
D	4.000	5.000	5.750
E	3.000	4.000	4.750
F	3.500	4.500	5.000
G	3.375	4.375	4.870
H	3.000	3.875	4.375
J	2.999/3.001	3.874/3.876	4.374/4.376
K	0.625	0.750	0.750
L	2.000	2.440	2.730
M	.472	0.788	0.985
N	1.060	1.313	1.813
P	1.000	1.250	1.750
R	0.563	0.687	0.938
S	3.000	3.875	4.375
T	0.125	0.250	0.250
U	0.1877/0.1892	0.1877/0.1892	0.1877/0.1892
V	0.156	0.156	0.156
W	0.563	0.688	0.938
X	2.200	2.200	2.200
Y	0.063	0.063	0.063
AA	CLEARANCE FOR 1/4 SHCS	CLEARANCE FOR 5/16 SHCS	CLEARANCE FOR 5/16 SHCS
BB	1/4-20 X 0.50 DEEP	5/16-18 X 0.63 DEEP	5/16-18 X 0.63 DEEP
CC	0.1892/0.1877 THRU	0.2505/0.2510 THRU	0.2505/0.2510 THRU
DD	0.1877/0.1892 X 0.25 DEEP	0.1877/0.1892 X 0.25 DEEP	0.1877/0.1892 X 0.25 DEEP
EE	1/4-20 THRU	5/16-18 THRU	5/16-18 THRU
FF	#10-32	#10-32	1/8 NPTF



PBS Series Power Block Slides

NUMATICS®

PBS Series Switch Information

	SWITCH OR BRACKET DESCRIPTION	STANDARD PART NO.	QUICK DISCONNECT PART NO.
1	8mm Threaded Barrel Prox NPN	PX08NS	PX08NQ
1	8mm Threaded Barrel Prox PNP	PX08PS	PX08PQ

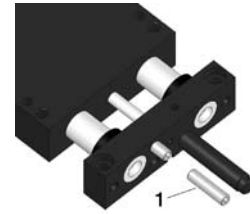

Prox Switch (NPN NO) Flying Leads - PX08NS
(PNP NO) Flying Leads - PX08PS

Prox Switch (NPN NO) 8 mm connector - PX08NQ
(PNP NO) 8 mm connector - PX08PQ

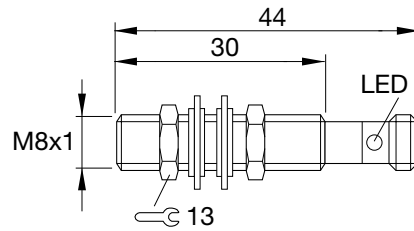
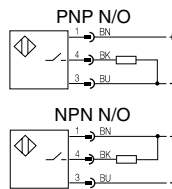
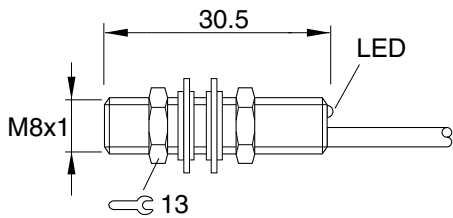

Sensing Data

Repeat accuracy R		≤5%
Ambient temperature range t_d	(°C)	-25...+70°C
Operating frequency f	(Hz)	1000
Utilization categories	(DC)	13
Function indication		YES

Electrical Data

Rated operational voltage U_e	(V)	24 DC
Supply voltage U_B	(V)	10...30 DC
Voltage drop U_d at I_e Stat./dyn.	(V)	≤2.5
Rated insulation voltage U_i	(V)	75 VDC
Load current capacity	(mA)	200
Current consumption	(mA)	≤25 / ≤12
Off-State Current I_r	(μA)	≤80
Protected against polarity reversal		YES
Short circuit protected		YES
Load Capacitance	(μF)	≤1.00

Mechanical Data

Degree of protection per IEC 529	IP 67
Housing material	stainless steel
Material of sensing face	PBTP
Connection	cable
No. of wires x gauge	3 x 26 AWG
Approvals	cULus

Female Connectors for Reed Switches and Hall Effect Sensors

Dimensions (mm)

TYPE	ORDER CODE
Straight, 5 m Cable	PXCST
Elbow, 5 m Calbe	PXC90

Straight Type

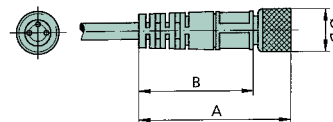

Elbow Type

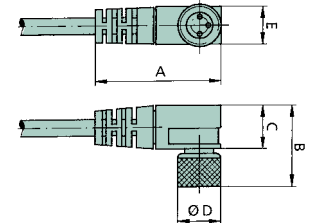

NUMATICS

*World Class Supplier
of Pneumatic Components*

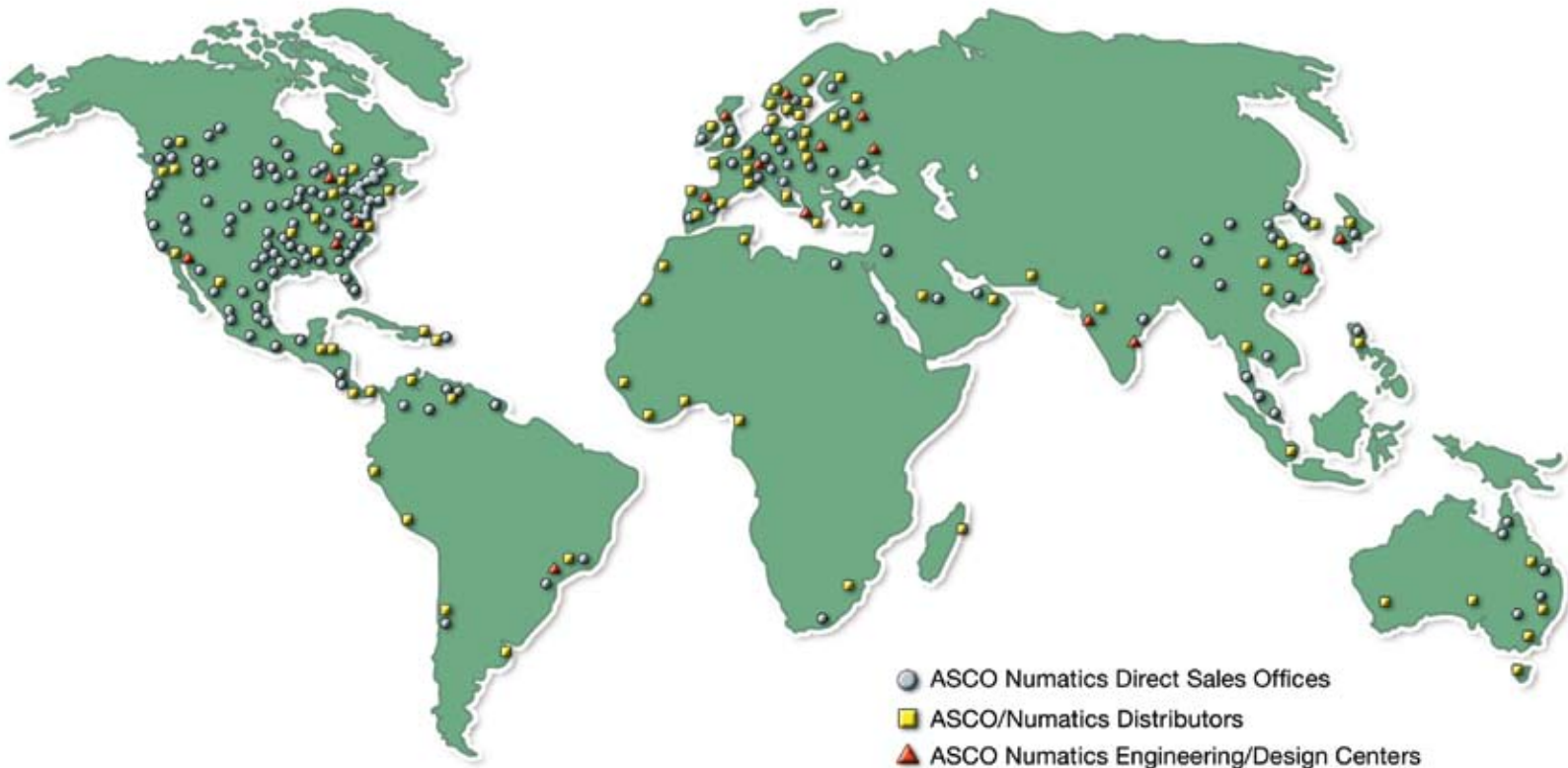

WORLD HEADQUARTERS

USA

Numatics, Incorporated

46280 Dylan Drive
Novi, Michigan 48377

P: 1-888-Numatics
1-888-686-2842

Canada

Numatics, Ltd

P: 519-452-1777

Mexico

Numatics de Mexico S.A. de C.V.

P: 52-222-284-6176

For a comprehensive listing of all Numatics production and distribution facilities worldwide, visit:

www.numatics.com